

Treillage Collection

Fuller Architectural Panels is a USA based firm that designs and manufactures standard & bespoke, classic & contemporary decorative treillage for interior and exterior applications. We are dedicated to providing high-quality, durable and visually appealing decorative treillage that enhance the overall look and feel of your space. Products are produced using high performance synthetic materials that are paint grade nor will not rot or rust. Our extensive experience allow us to work with world-renowned Architects, Interior Designers and Millwork Companies.

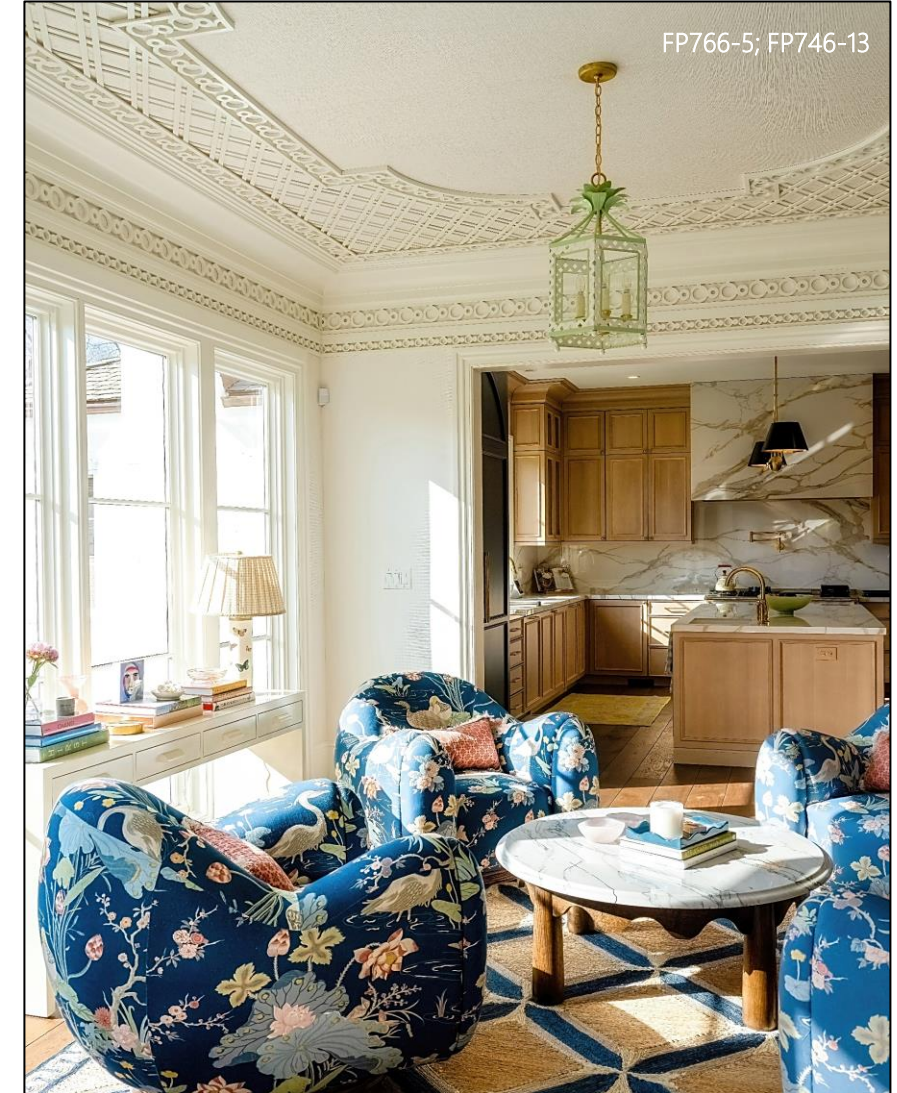

Gracious Opulence





FP765-4 / FP743-9



FP766 / FP767 / FP747 / CUSTOM ARCH



FP772 / FP745 / FP762



FP753-4



FP184 / FP743



FP769-7



SKU:FP753 / FP747 / FP748



FP753-5; FP790-8



FP762-5; FP767-8; FP747-13



FP753-5; FP742-13

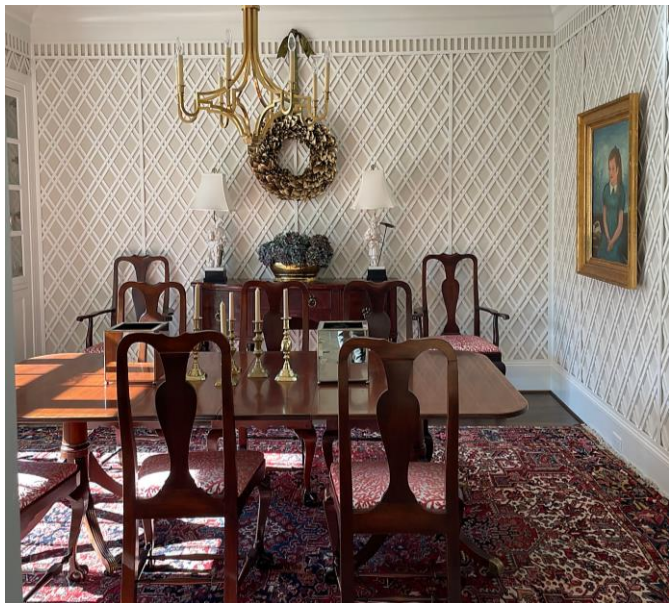

FP766-5; FP742-13

Diamond Arrangement

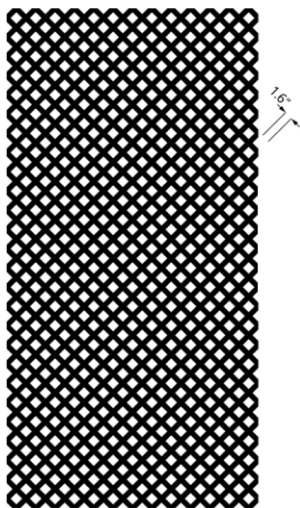

SKU: FP700-5

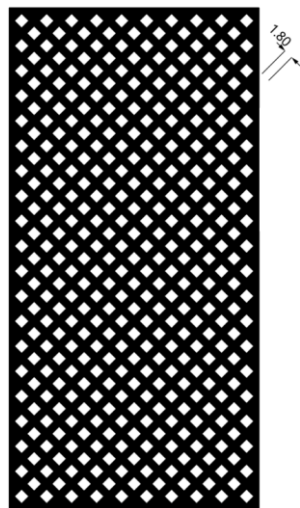

SKU: FP549-5

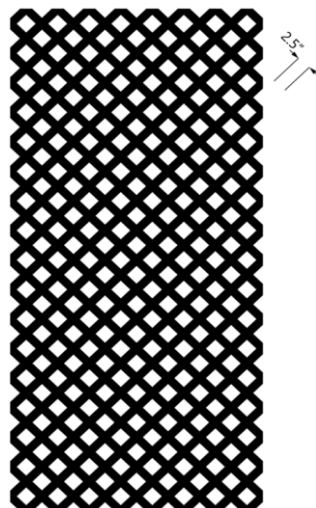

SKU: FP753-5

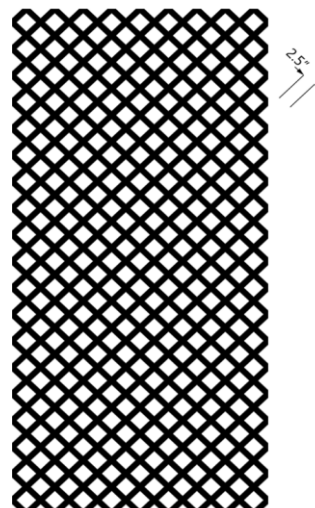

SKU: FP755-5

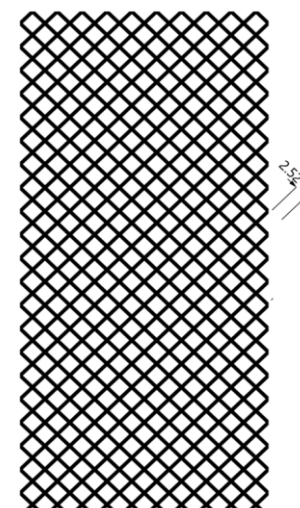

SKU: FP762-5

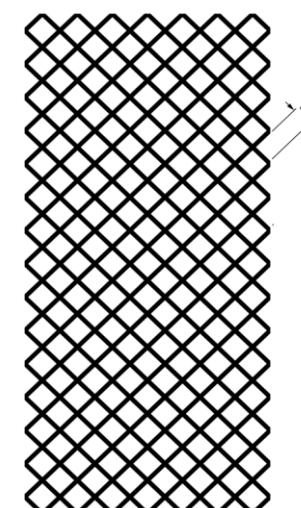

SKU: FP765-5

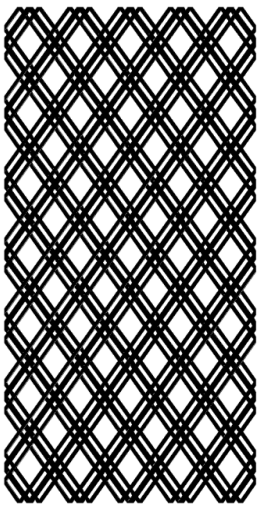

SKU: FP-916-5

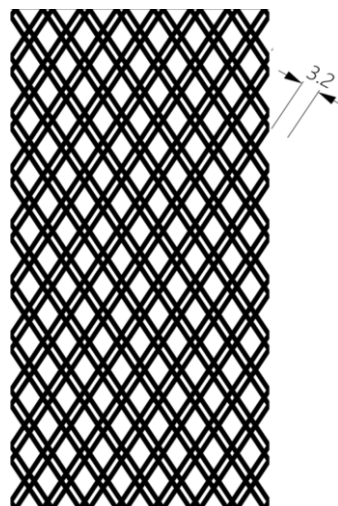

SKU: FP766-5

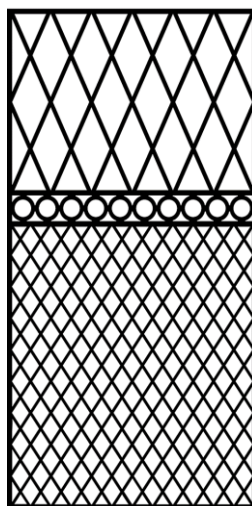

SKU: FP714-5

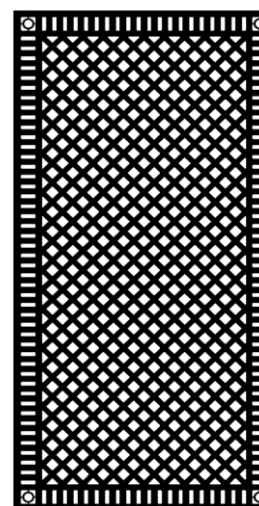

SKU: FP704-5

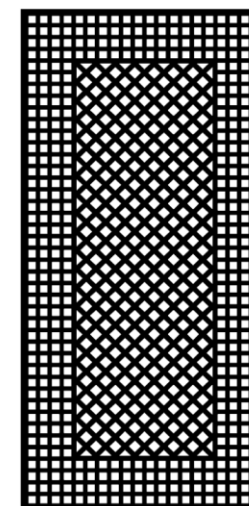

SKU: FP705-5

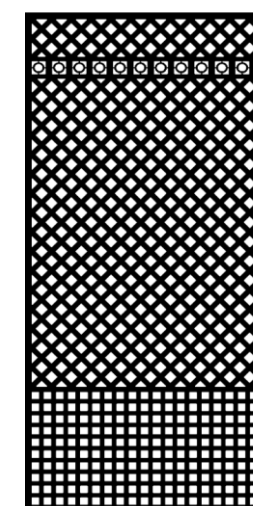

SKU: FP707-5

Diamond Arrangement

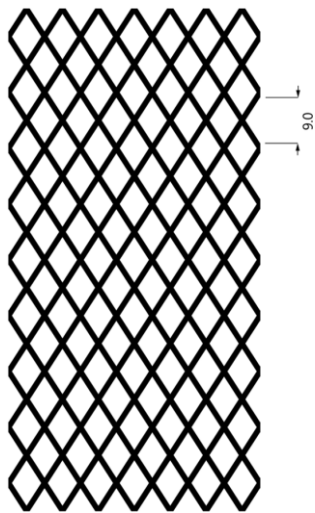

SKU: FP786-6

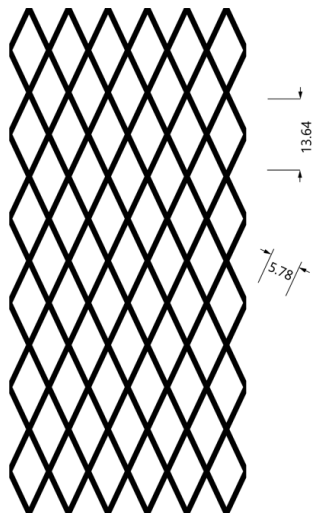

SKU: FP927-6 (repeat 96"x44.94")

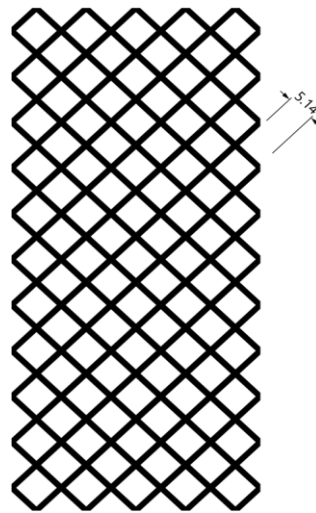

SKU: FP945-6

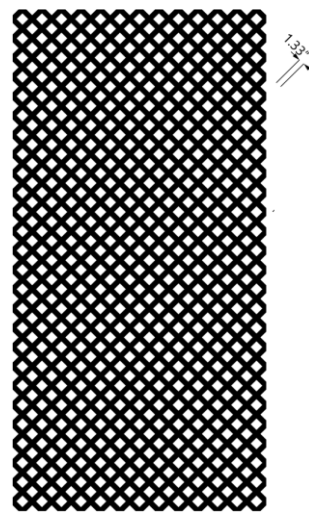

SKU: FP144-6

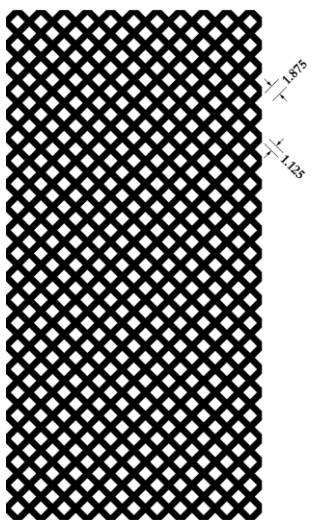

SKU: FP965-6 (milled 93.33"x46.66")

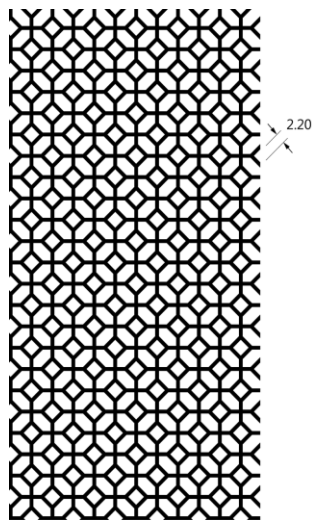

SKU: FP929-6



SKU: FP765-5; FP747-13; FP748-18



SKU: FP765-5; FP772-5



SKU: FP549-5; FP747-9; FP742-13; FP748-11; FP764-5

Karlisch Photography

Micro Diamond

TREILLAGE PANELS

96"x48" BORE DIMENSION WITH FRAME

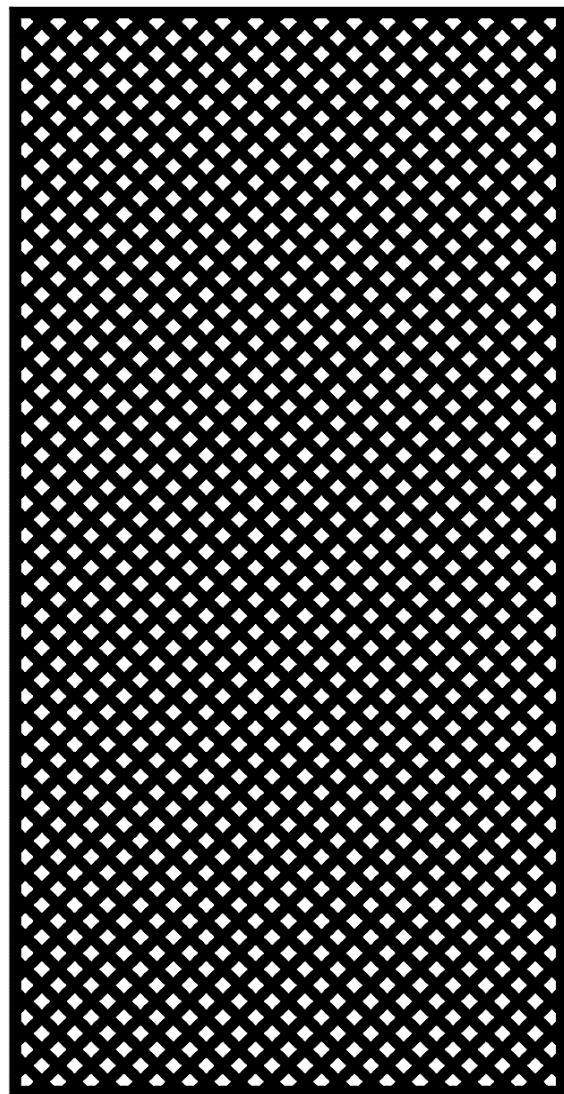

SKU: FP938-7

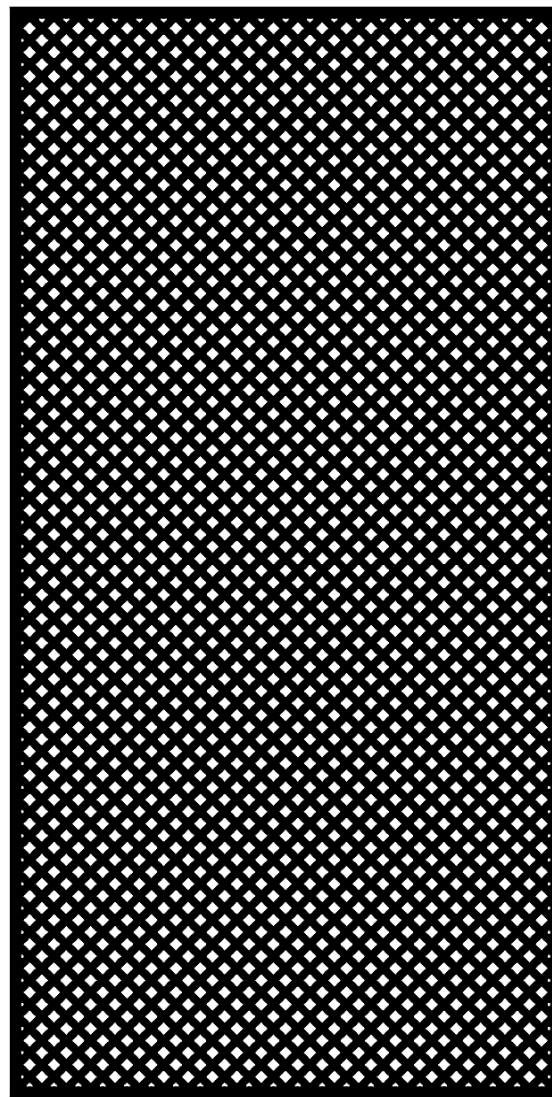

SKU: FP936-7

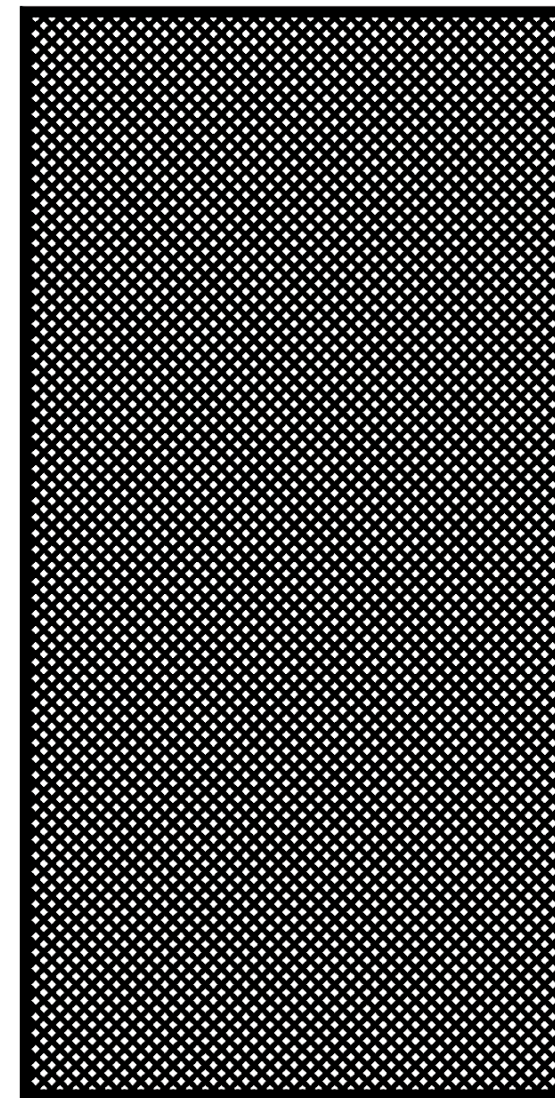

SKU: FP926-7

Square Arrangement

TREILLAGE PANELS

96"x48" BORE DIMENSION WITH FRAME

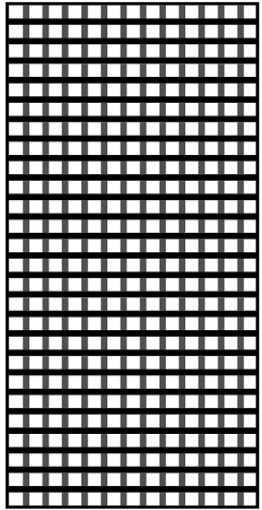

SKU: FP701-8 (repeat 96"x48")

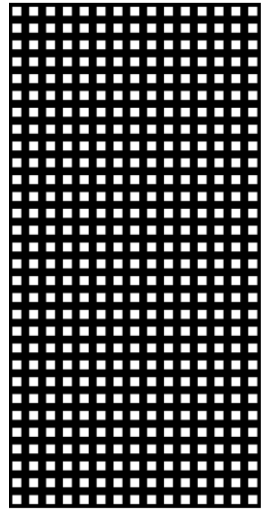

SKU: FP538-8

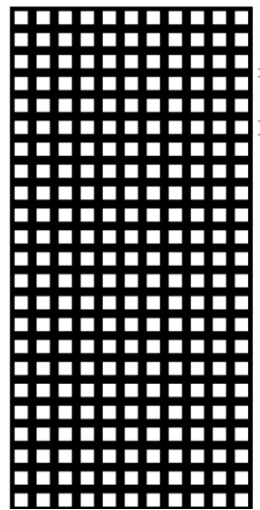

SKU: FP790-8 (repeat 96"x45.5")

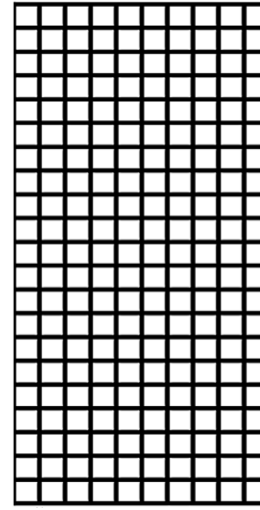

SKU: FP767-8

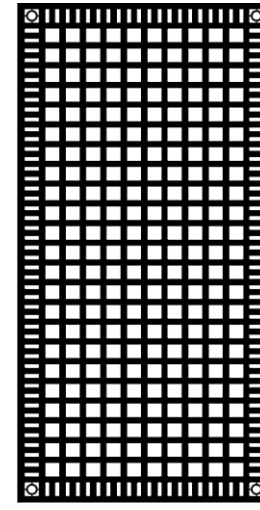

SKU: FP706-8

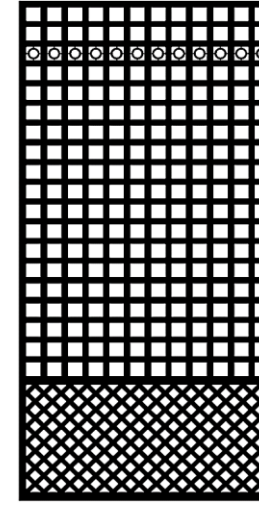

SKU: FP708-8

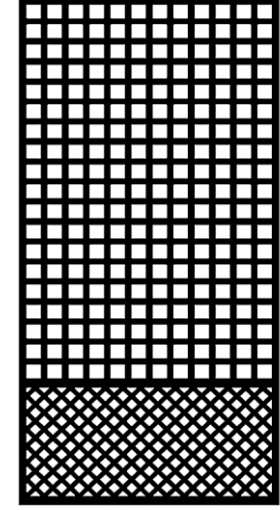

SKU: FP709-8

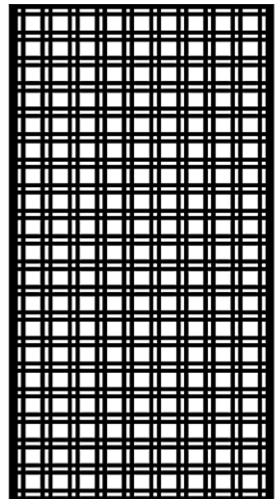

SKU: FP768-8

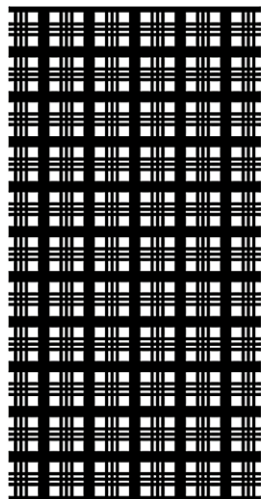

SKU: FP769-8

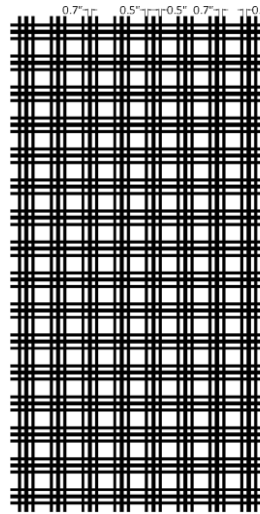

SKU: FP922-8

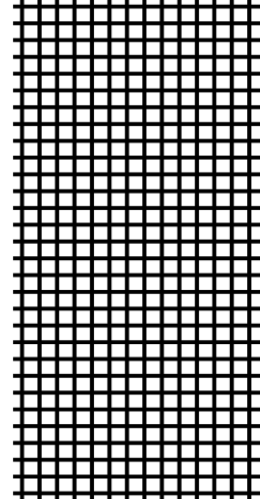

SKU: FP924-8 (repeat 94.79"x47.4")

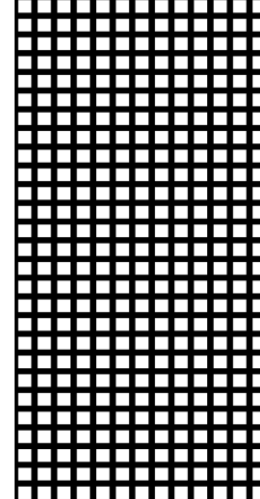

SKU: FP970-8 (repeat 94.5"x45.5")

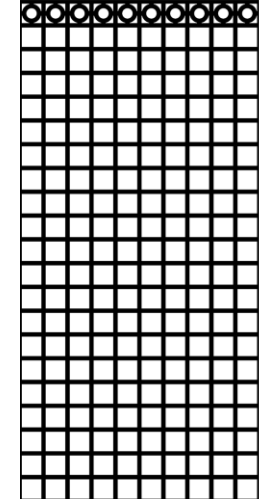

SKU: FP977-8 (repeat 96"x45.4")

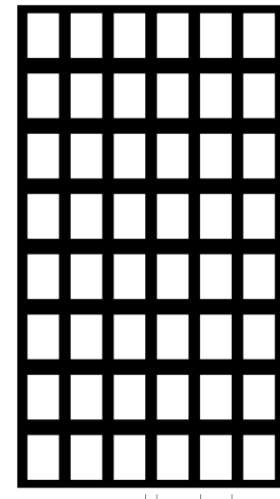

SKU: FP976-8 (repeat 80"x48")

Micro Square

TREILLAGE PANELS

96"x48" BORE DIMENSION WITH FRAME

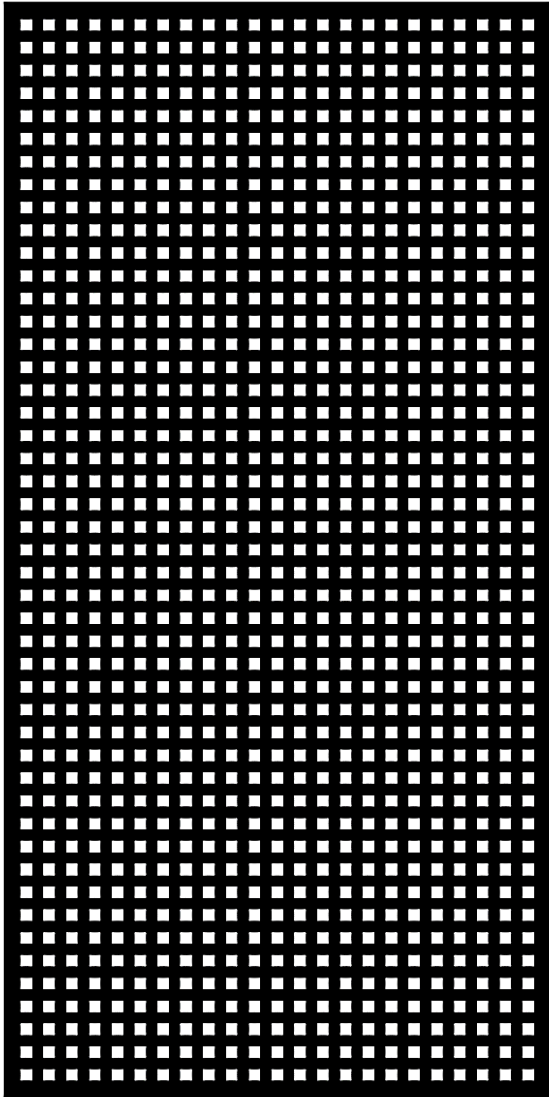

SKU: FP943-9

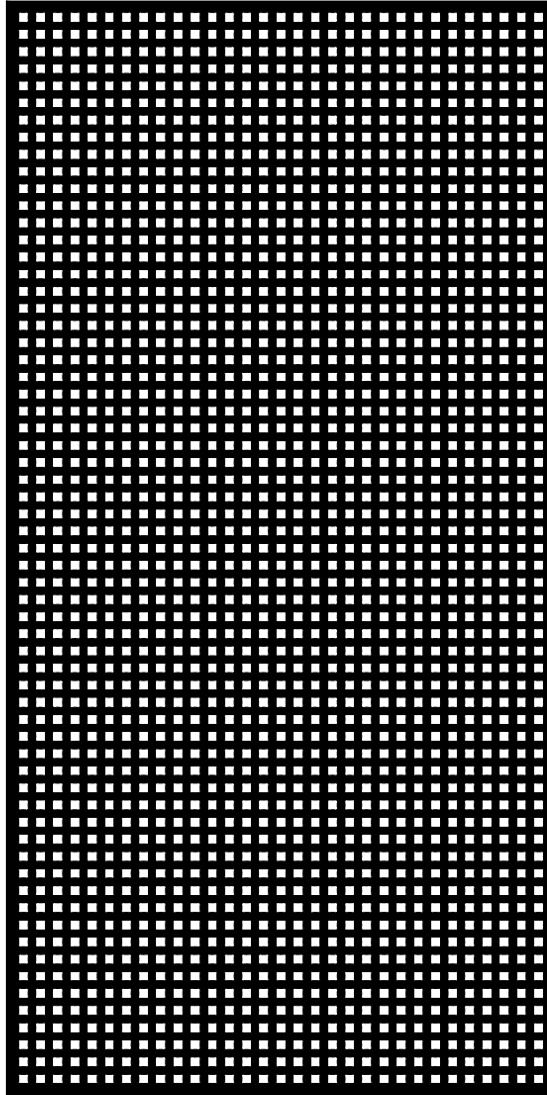

SKU: FP939-9

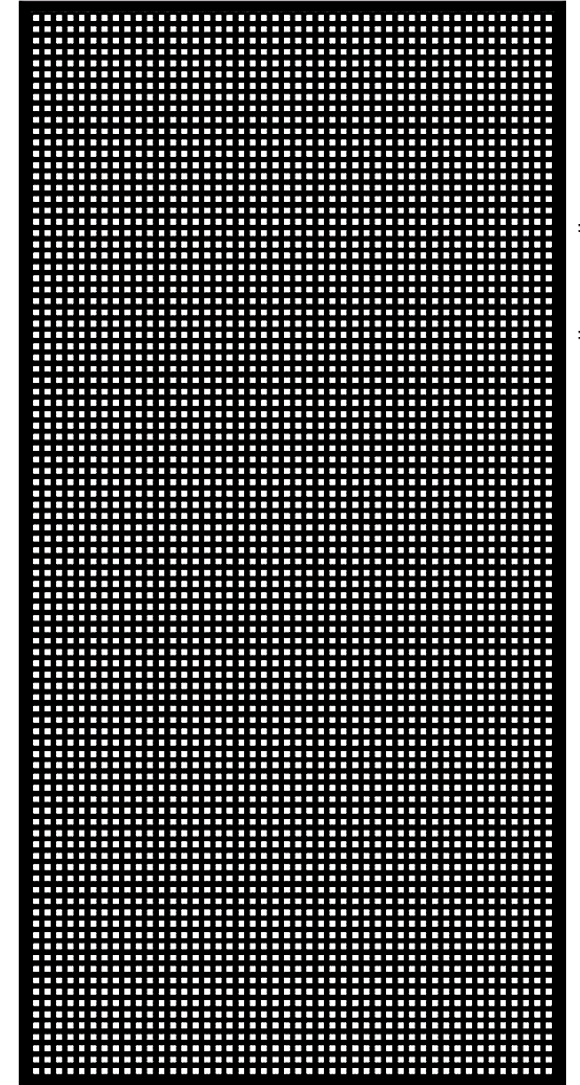

SKU: FP933-9

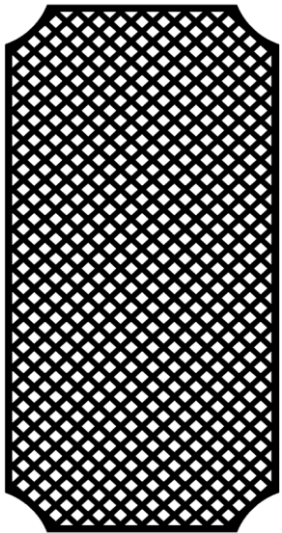

SKU: FP702-10

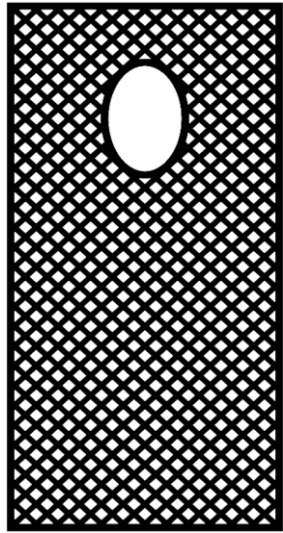

SKU: FP710-10

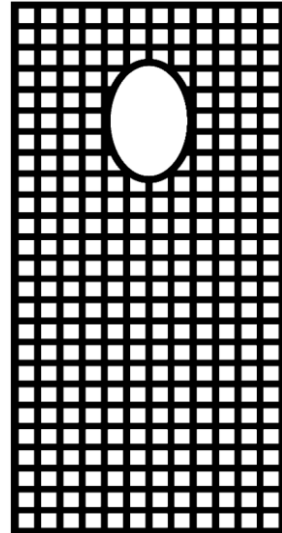

SKU: FP711-10

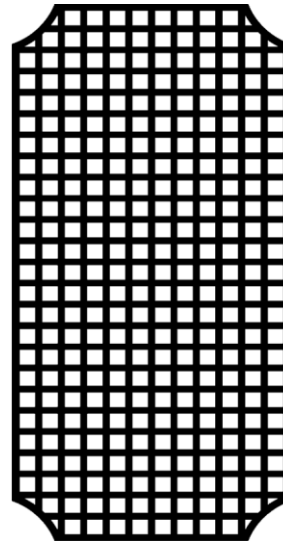

SKU: FP703-10

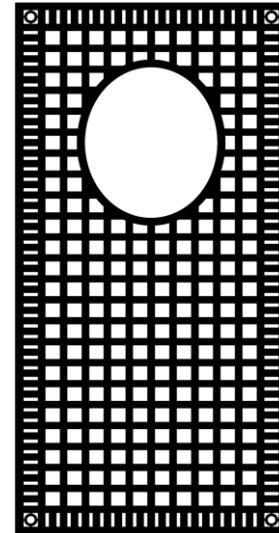

SKU: FP716-10



SKU: FP766-5

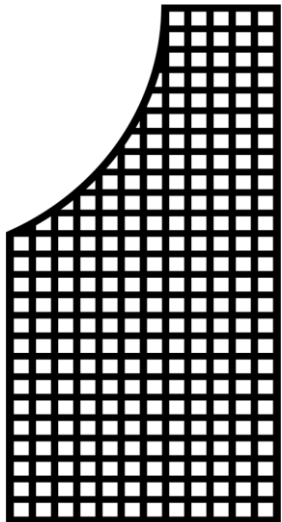

SKU: FP717-10

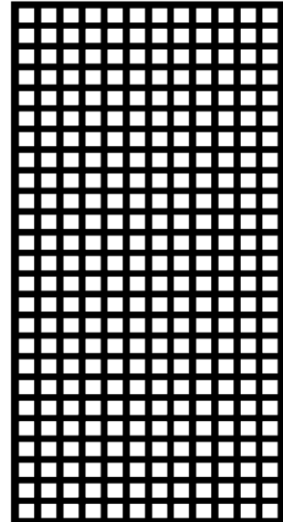

SKU: FP701-10

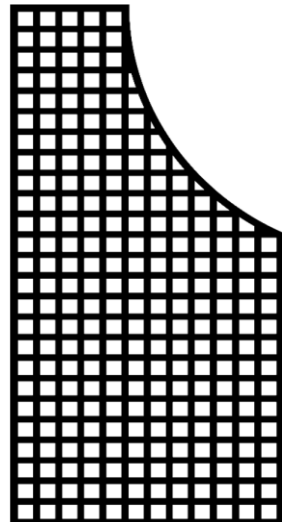

SKU: FP719-10

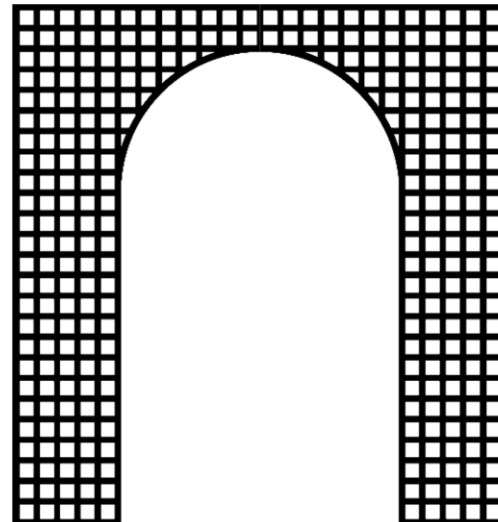

SKU: FP726-10



SKU: FP765-5; FP747-13



SKU: FP746-13; FP748-18

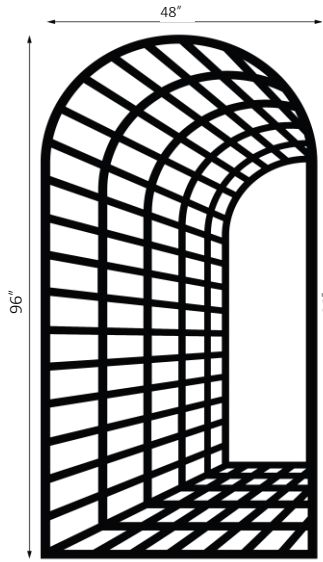

SKU: FP720-11

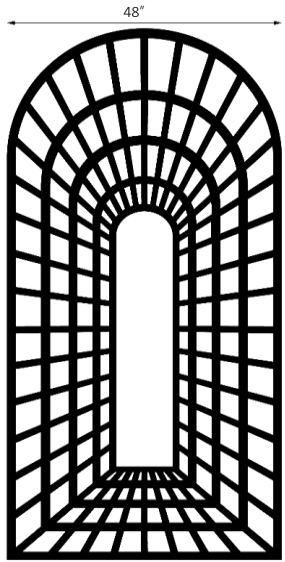

SKU: FP721-11

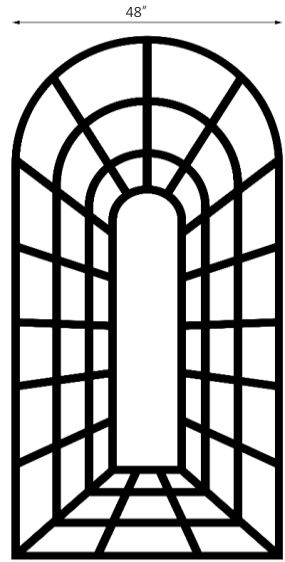

SKU: FP722-11

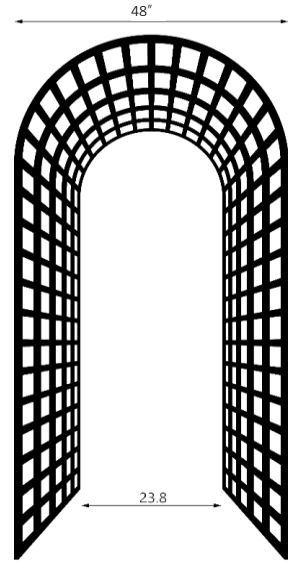

SKU: FP723-11

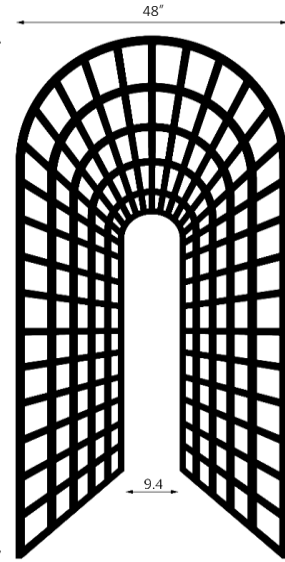

SKU: FP724-11

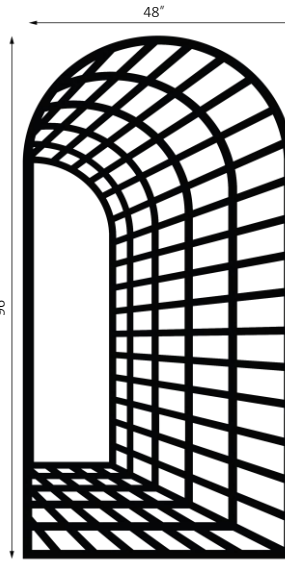

SKU: FP725-11

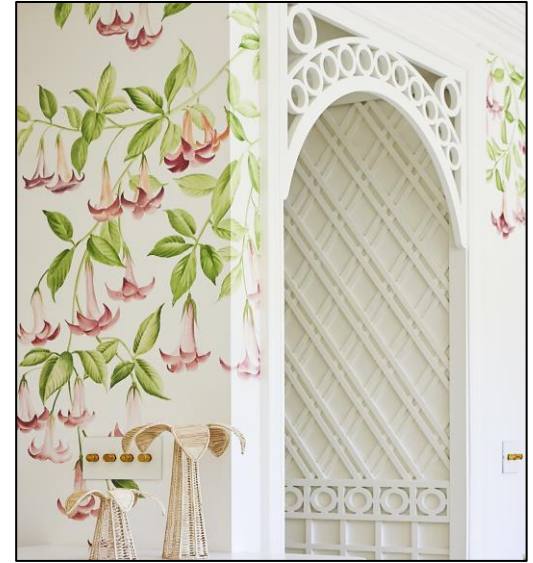

FP713-11; FP766-5; FP741-13; FP767-8



SKU: FP395; FP271; CUSTOM LADDER

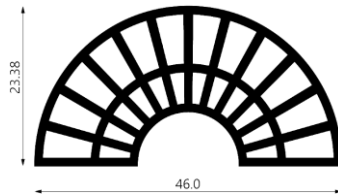

SKU: FP733-11

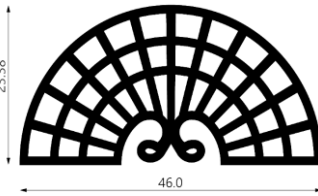

SKU: FP734-11

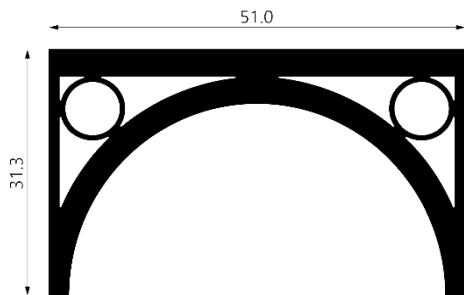

SKU: FP712-11

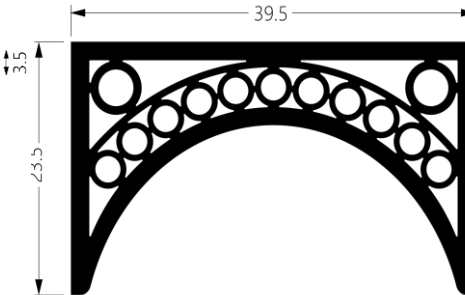

SKU: FP713-11

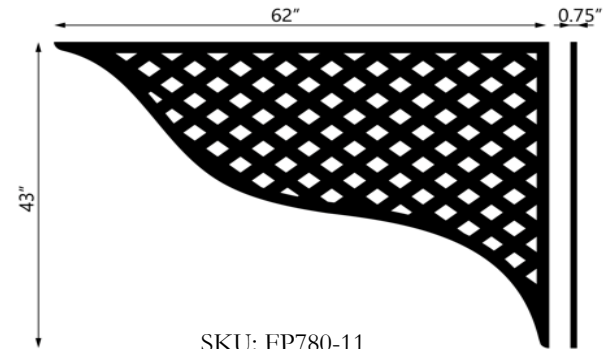

SKU: FP780-11

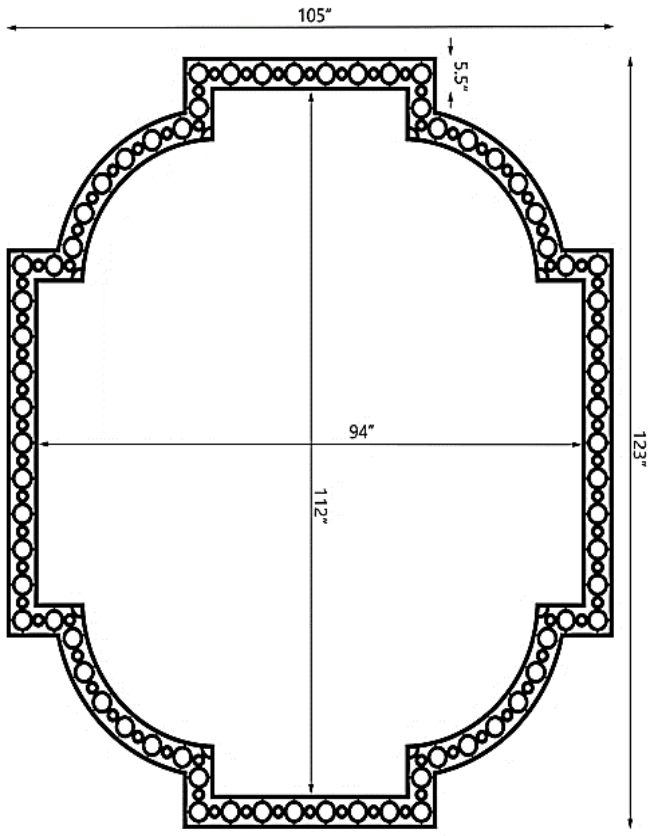

SKU: Custom Based on FP745

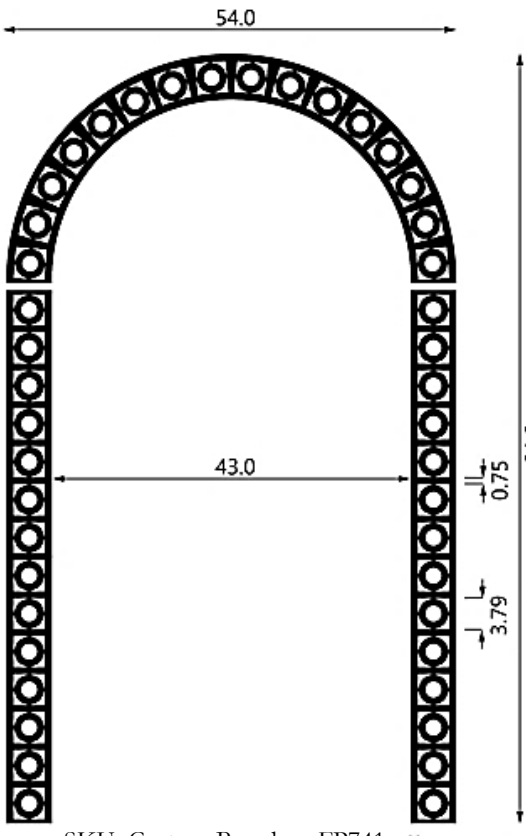

SKU: Custom Based on FP741

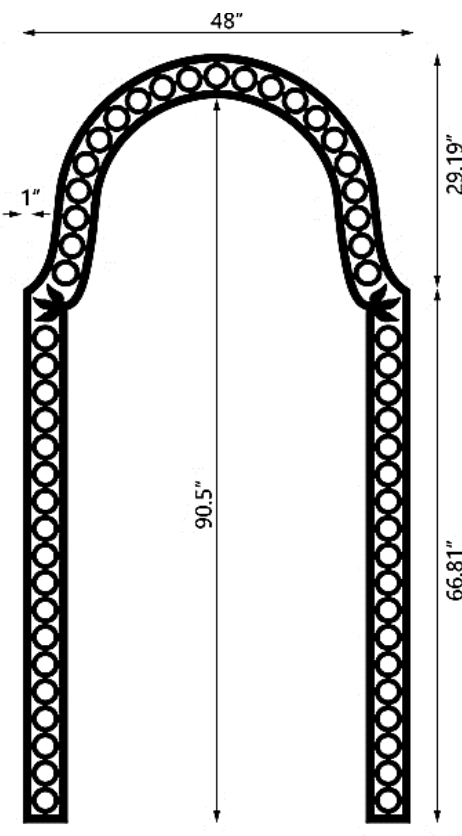

SKU: Custom Based on FP747

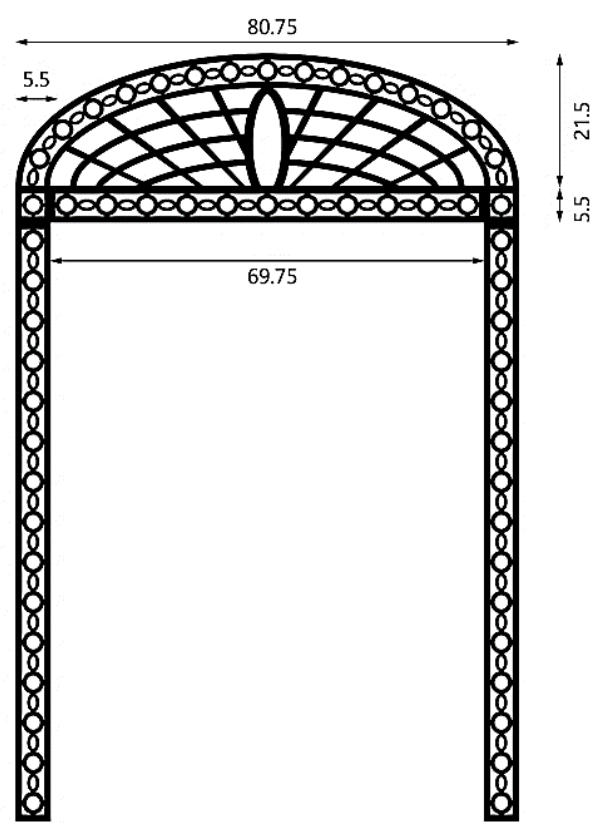

SKU: Custom Based on FP743

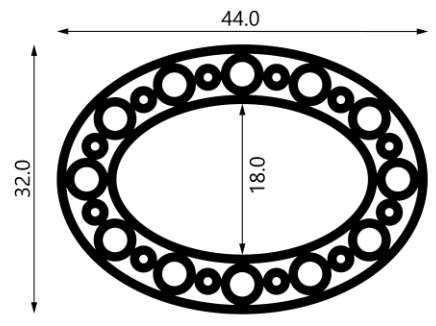

FP791-12

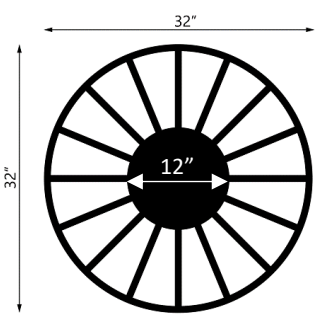

FP792-12

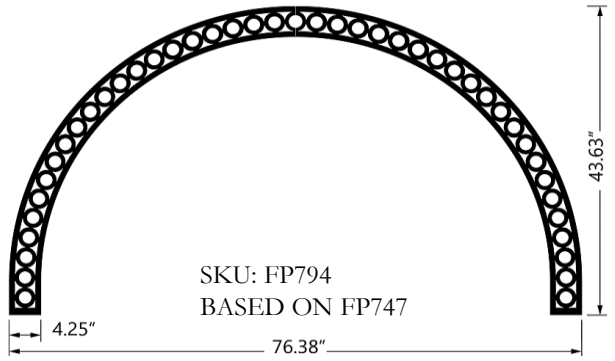

SKU: FP794
BASED ON FP747

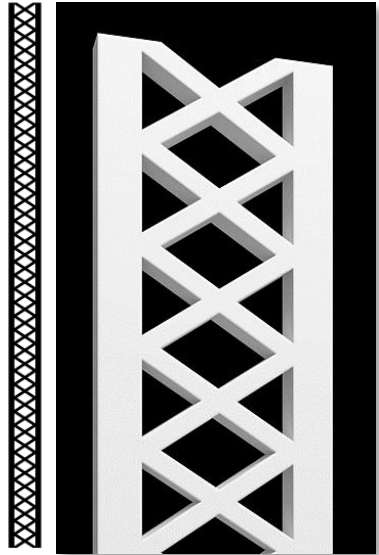

SKU: FP740-13 95.6"x5.5"

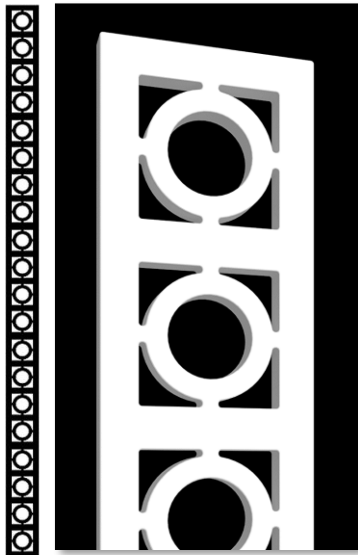

SKU: FP741-13 95"x5.5"

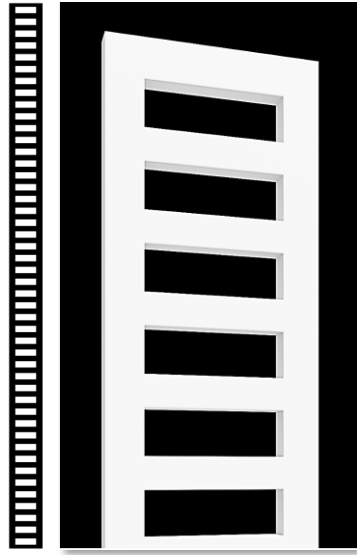

SKU: FP742-13 95"x5.5"

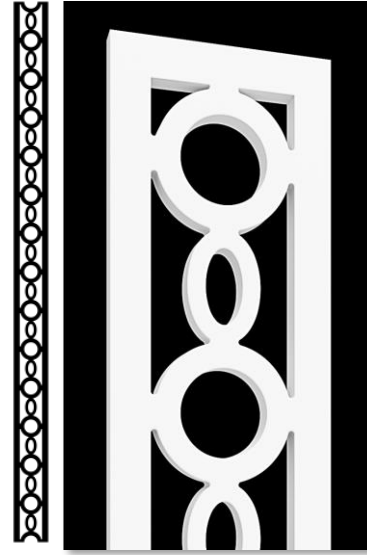

SKU: FP743-13 90.15"x5.5"

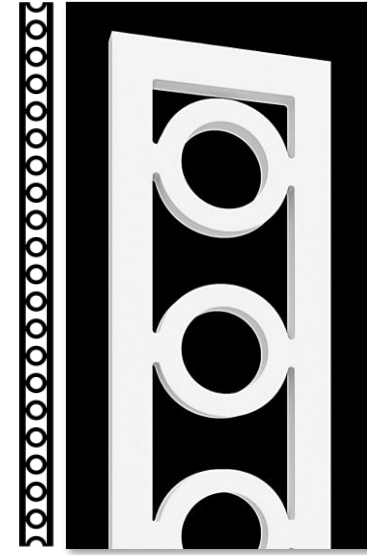

SKU: FP744-13 94.67"x5.5"

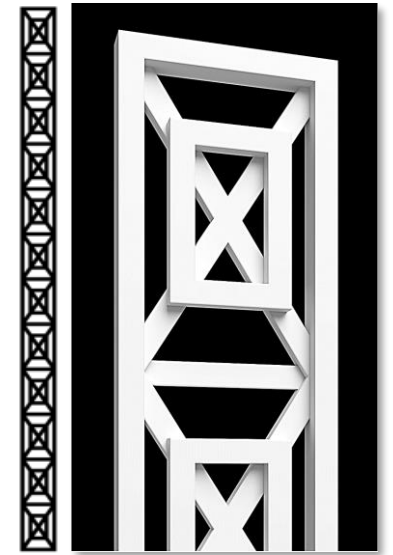

SKU: FP918-13 95"x5.625"

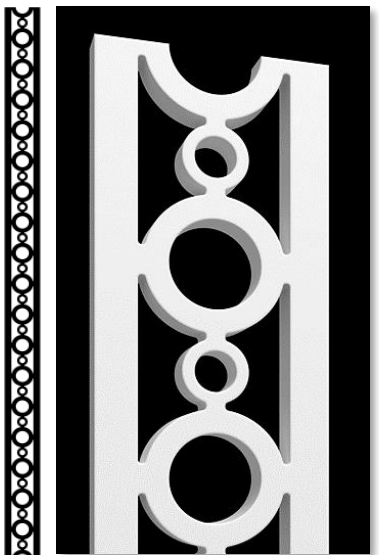

SKU: FP745-13 95.52"x5.5"

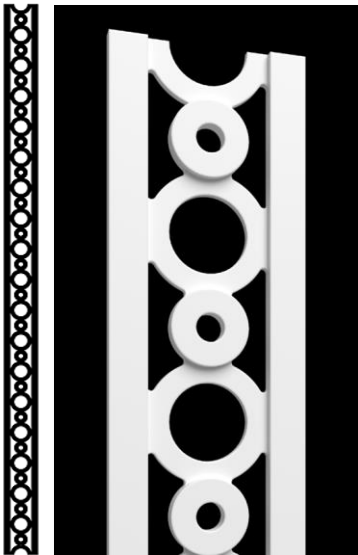

SKU: FP746-13 94.6"x5.5"

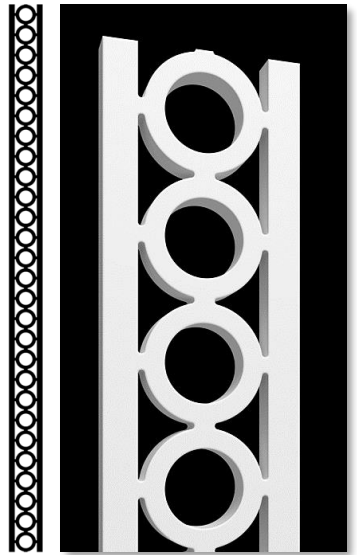

SKU: FP747-13 93.7"x5.5"

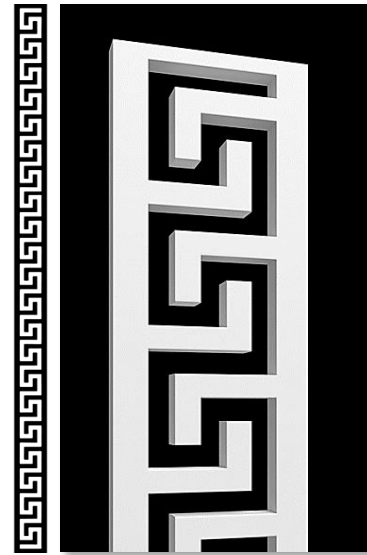

SKU: FP750-13 95"x5.5"

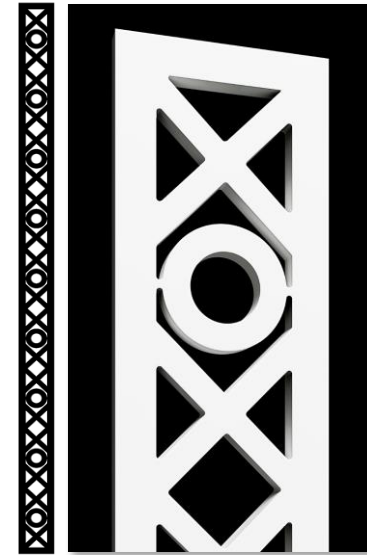

SKU: FP756-1 95"x5.5"



SKU: FP766-5 / FP750-10

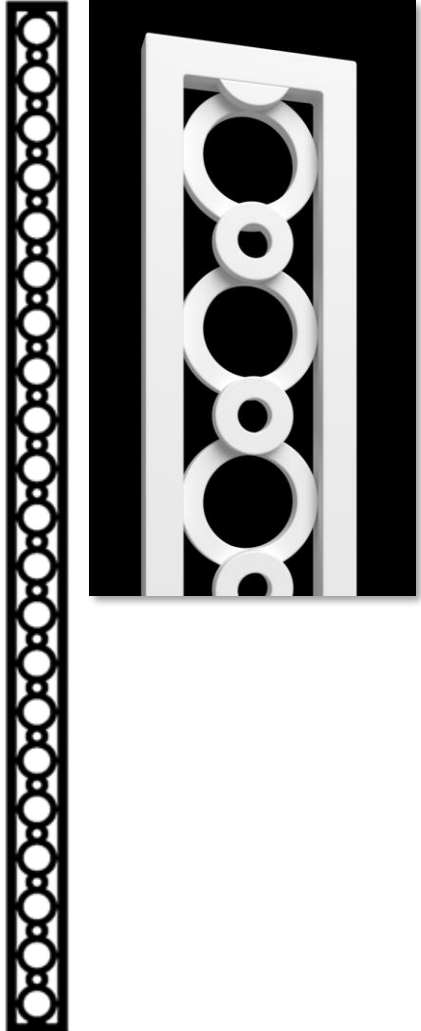

SKU: FP925-14
96"x5-1/2"

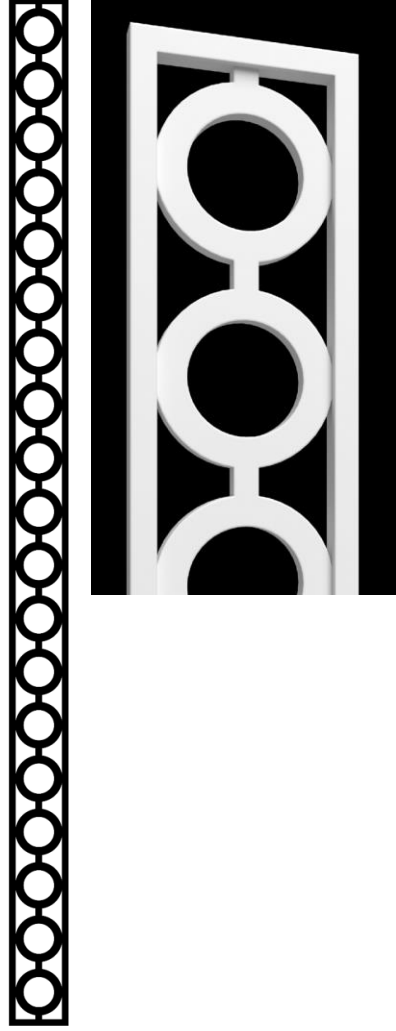

SKU: FP937-14
96"x5-1/2"

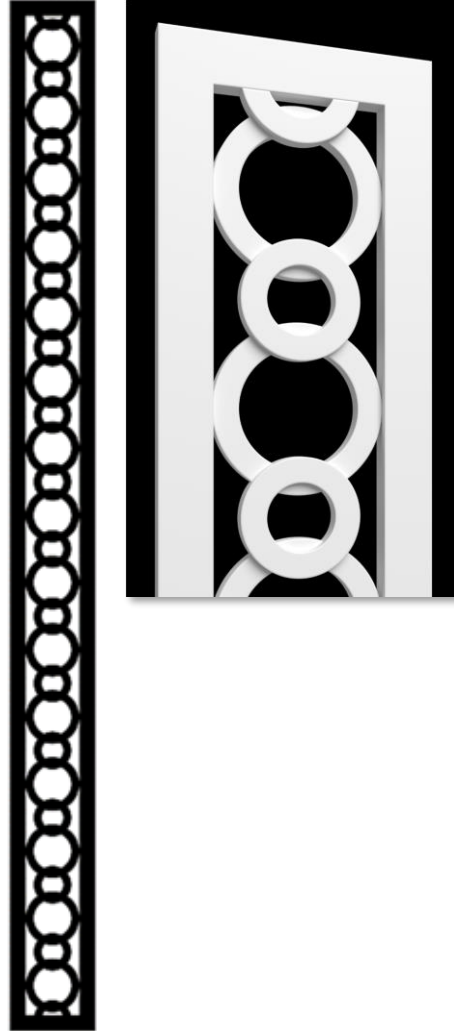

SKU: FP785-14
96"x8"

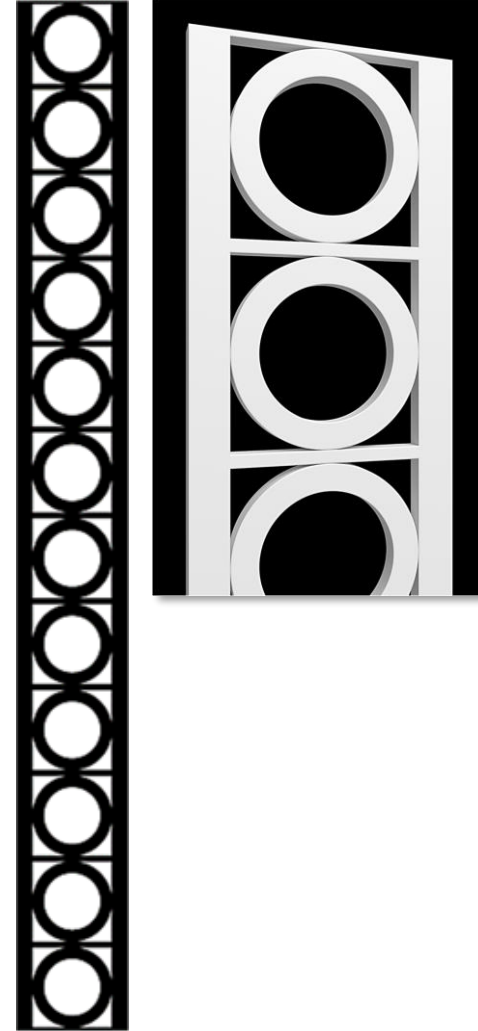

SKU: FP923-14
96"x9.8"



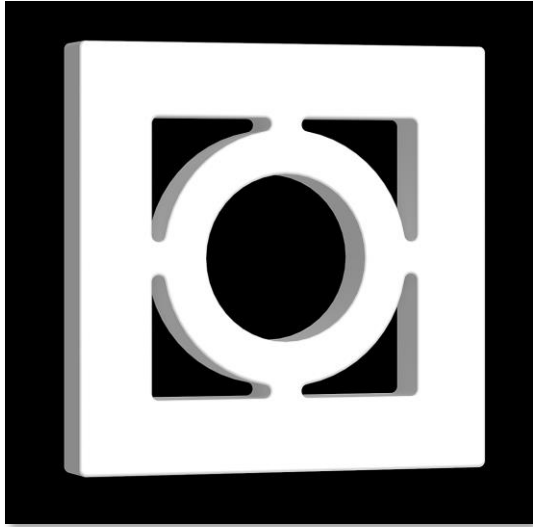

SKU: FP748-18

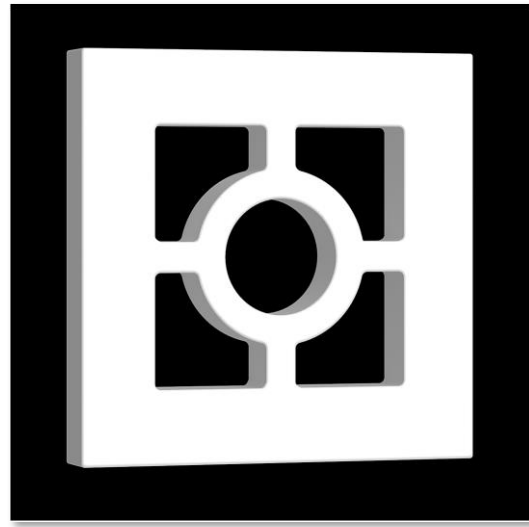

SKU: FP758-18

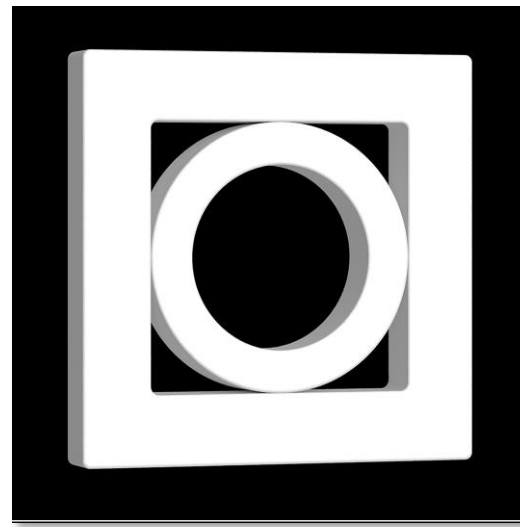

SKU: FP917-18 (HAND ASSEMBLED BY INSTALLER)



SKU: FP745-13 / FP748-18



SKU: FP753-5

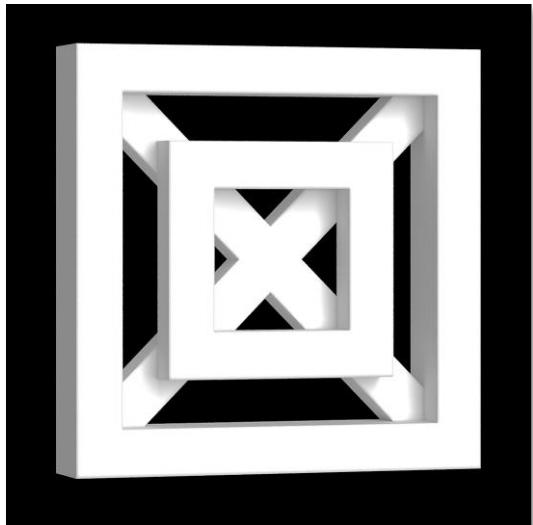

SKU: FP920-18

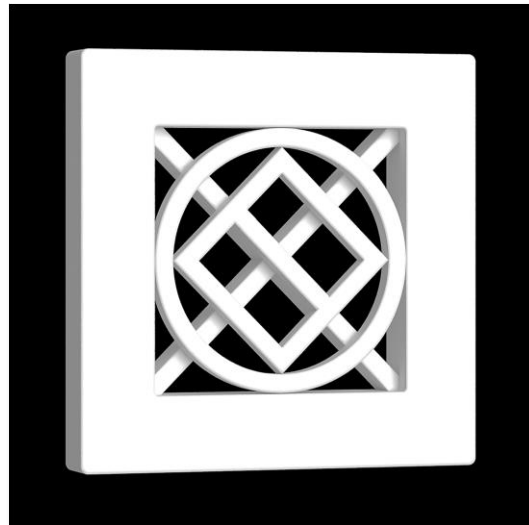

SKU: FP928-18

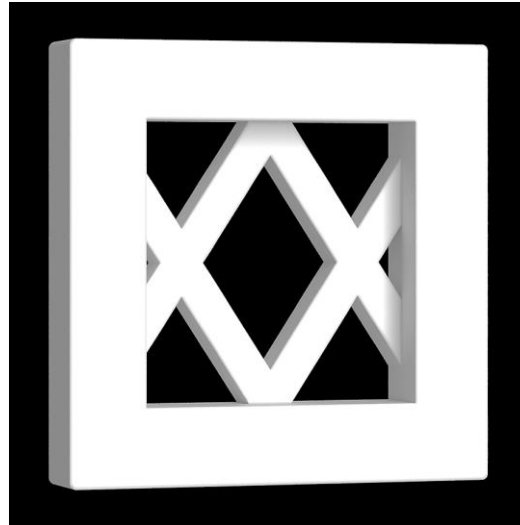

SKU: FP919-18



SKU: FP769-8

SINGLE SWITCH

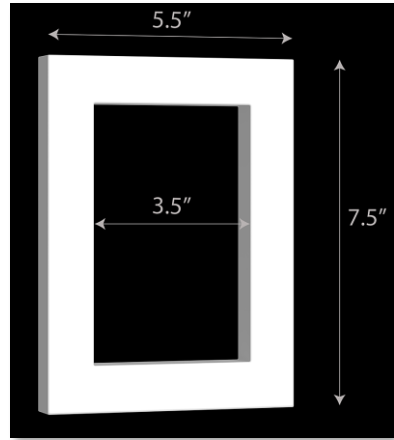

SKU: FP795-19

DOUBLE SWITCH

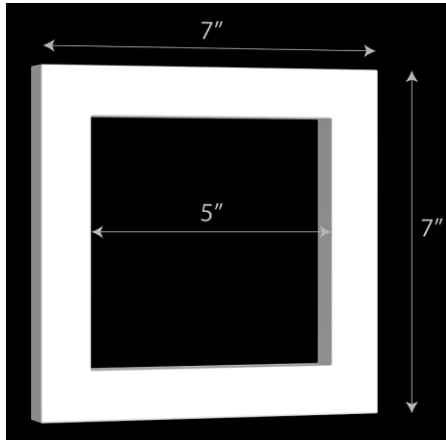

SKU: FP796-19

TRIPLE SWITCH

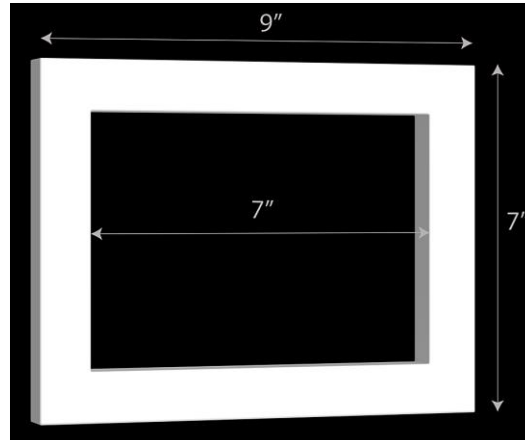

SKU: FP797-19

ROUND PLATE 6-3/4"

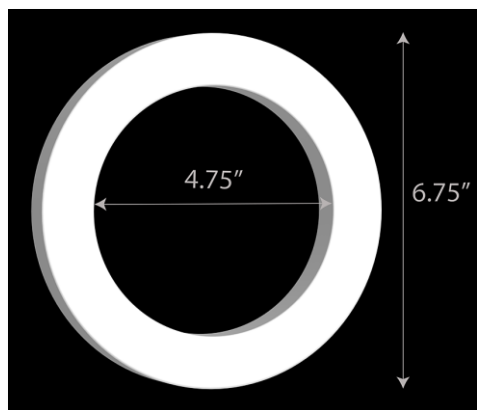

SKU: FP798-19

ROUND PLATE 8-1/2"

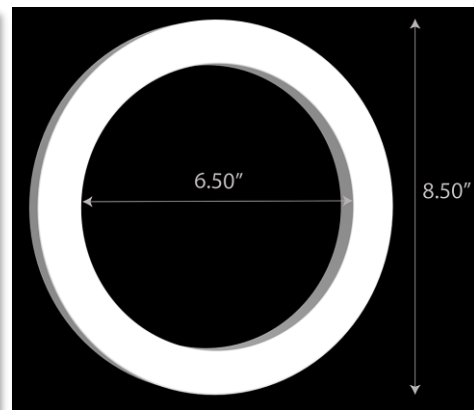

SKU: FP799-19

ROUND PLATE 9-1/4"

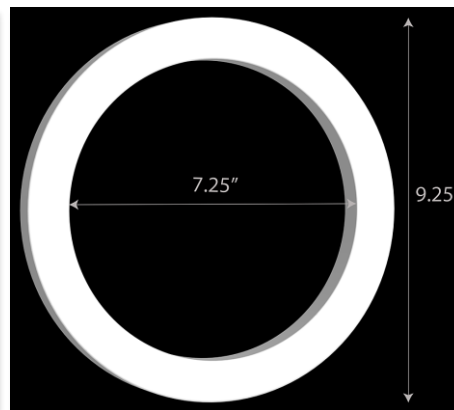

SKU: FP800-19



Milling Options



SKU: FP767-8/FP747-13

We offer three milling options of which are customizable in hole size, slat width and pattern orientation.

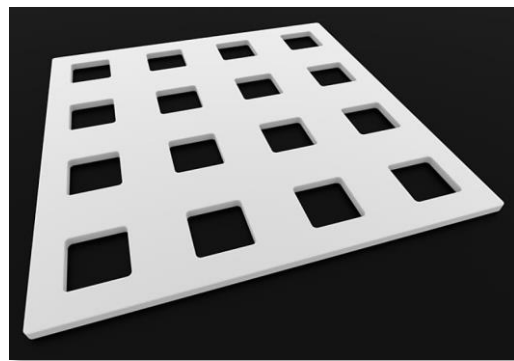

Type: **Bore**
Min. Thickness: 1/4"
Max. Panel Size 96"X48"

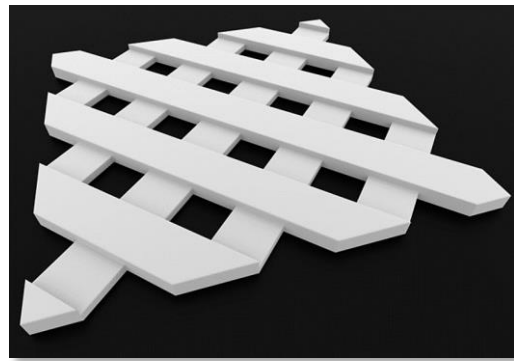

Type: **Single Mill**
Min. Thickness: 1/2"
Max. Panel Size: 96"X48"

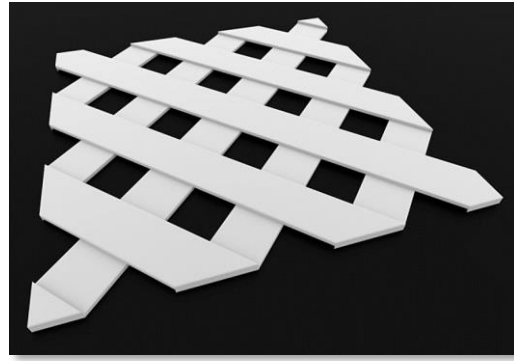

Type: **Double Mill**
Min. Thickness: 1/2"
Max. Panel Size 96"X48"

FULLER

ARCHITECTURAL PANELS

MILLWORK JEWELRY



FP753-5 / FP790-8 / FP747-13 / CUSTOM

Brantley Photography



FP746-13



FP765-5 / FP760



SKU: FP765-5; FP745-13; FP791-12



SKU: FP753-6 / FP746-13 / FP748-18



SKU: FP766-5 / FP743-13 / CUSTOM



Installation

- Install using conventional woodworking techniques.
- Specialty adhesives may be required. Always test prior to installation.
- Carbide tipped blades are recommended.
- Glue all joints to prevent separation.

Storage and Handling

- Store items on a flat surface and away from heat above 130 degrees.
- Keep product free of dirt and debris. Use warm water with detergent to clean.

Additional

- LUSSOCOR™ material must be painted.
- Available LUSSOCOR™ material thicknesses: 1/4", 1/2", 3/4", 1", 1.5" and 2"
- Available PVC raw material colors: white.
- Available PVC material thicknesses: 1/4", 1/2", 3/4", 1" and 1-1/2"
- Standard dimensions subject to change without notice.
- 20% restock fee on approved returns. Custom projects are not returnable.
- Pricing is USD and does not include packaging, shipping and applicable taxes.
- Terms and Conditions found on website.
- Installation and Finishing documentation found on website.
- Lead times based on milling type and quantity and are subject to change.
- 2 to 2-1/2 hrs budget for milled panel/each barring unforeseen events.
- 1 to 1-1/2 hrs budget for bore panel/each barring unforeseen events.
- Installation and Finishing documentation found online.
- Warranty details found online.
- Terms & Conditions found online.
- Buyer's responsibility to pay Sales & Use Tax.

Warranty

3 YEAR LIMITED WARRANTY

Fuller Architectural Panels (hereinafter "Manufacturer") warrants that all products will not rot, split or suffer structural damage from termite or fungal decay for a period of three (3) years from Fuller Architectural Panels. *Purchaser's sole remedy for any claim whatsoever, whether in contract, warranty, tort, or strict liability, arising out of the use, storage or possession of Fuller Architectural Panels, including without limitation any claim that Fuller Architectural Panels fail to perform as warranted, shall be replaced with Fuller Architectural Panels. To obtain replacement, the original owner must submit this warranty certificate, with the original purchase invoice indicating the date of purchase, picture of the defective product and detailed description to Fuller Architectural Panels, 2009 Fairview Road #6731 Raleigh, North Carolina 27628.

MANUFACTURER'S LIABILITY UNDER WARRANTY IS LIMITED SOLELY TO REPLACEMENT OF DEFECTIVE PRODUCT. THIS WARRANTY SHALL NOT APPLY TO PRODUCT WHICH HAS NOT BEEN INSTALLED IN ACCORDANCE WITH INSTALLATION GUIDELINES SPECIFIED IN THE MANUFACTURER'S "INSTALLATION INSTRUCTIONS", OR TO PRODUCT WHICH HAS BEEN USED, PLACED UNDER OR SUBJECTED TO ABNORMAL USE CONDITIONS OR USED, MODIFIED OR OTHERWISE TREATED IN ANY MANNER OTHER THAN AS INTENDED BY MANUFACTURER. IN NO EVENT SHALL MANUFACTURER BE LIABLE FOR LABOR, EXEMPLARY OR CONSEQUENTIAL DAMAGES OF ANY KIND WHATSOEVER. PURCHASER IS SOLELY RESPONSIBLE FOR DETERMINING THE SUITABILITY OF USE OR APPLICATION OF ANY FULLER ARCHITECTURAL PRODUCT, OR WHETHER PRODUCT MEETS REQUIREMENTS OF APPLICABLE BUILDING CODES OR SAFETY CODES FOR SPECIFIC APPLICATIONS. No person or entity is Authorized by Manufacturer to make, and Manufacturer shall not be bound by any statement or representation as to the performance of Fuller Architectural Panels products other than amended or altered except in a written instrument signed by Manufacturer and Purchaser.